Aesthetic Brickwork

General Guide

Last Updated: December 2023



The Brick Development Association

The Brick Development Association is the national authority on clay bricks and pavers.

The membership accounts for almost 99% of the bricks produced in the UK; the BDA members are committed to manufacturing products of outstanding quality and developing one of the nation's most productive and sustainable supply chains.

The BDA Guides and Technical Guides are continually updated to take account of the latest materials, systems and products developed in the clay brick and paver sector.

We are grateful to our various team of experts, contributors, staff as well as our membership whose support, we are eternally grateful for.

Keith Aldis
Chief Executive Officer
Brick Development Association

Scope of Document

This is an initial guidance document for the general public and members of the construction profession.

Aesthetic brickwork can involve a number of structural and environmental issues, so this document is not intended to be a comprehensive guide, but rather a collection of finished brickwork and options available; with signposts to further information, if required.

The BDA are committed to providing impartial and authoritative information.

We make every effort to ensure the accuracy and quality of information and guidance when it is published. However, we can take no responsibility for the subsequent use of this information, nor for any errors or omissions it may contain.

UK Brick Makers



Bulmer

www.bulmerbrickandtile.co.uk
Sudbury (7)

Forterra

www.forterra.co.uk
Accrington (1), Claughton Manor (13), Cradley (14), Desford (16), Howley Park (24), Kirton (27), Measham (31), Whittlesey (47), Wilnecote (49)

H.G. Matthews

www.hgmatthews.com
Bellingdon (23)

Ibstock

www.ibstockbrick.co.uk
Aldridge & Atlas (2,3), Ashdown (4), Cattybrook (9), Chailey (10), Chesterton (12), Dorket Head (17), Ellistown (18), Eclipse (19), Laybrook (28), Lodge Lane (29), Parkhouse (34), Ravenhead (36), South Holmwood (39), Swanage (41), Throckley (42), Birtley (44)

Ketley

www.ketley-brick.co.uk
Brierley Hill (25)

Matclad

www.matclad.co.uk
Wreham (30)

Michelmersh

www.mbhplc.co.uk
Michelmersh (32), Blockleys (6), Charnwood (11), Carlton (8), Freshfield (21)

Northcot

www.northcotbrick.co.uk
Blockley (33)

Raeburn

www.raeburnbrick.co.uk
Blantyne (35)

Sussex Handmade Brick

www.sussexhandmadebrick.co.uk
Sussex Handmade Brick (40)

W.H Collier

www.whcollier.co.uk
Marks Tey (48)

Wienerberger

www.wienerberger.co.uk
Denton (15), Ewhurst (20), Hartleybury (22), Kingsbury (26), Sandown (37), Smeed Dean (38), Todhills (43), Waresley (45), Warnham (46)

York Handmade

www.yorkhandmade.co.uk
Alne (50)

Contents

Introduction	5
Mortar Colours	6
Blending Brickwork	7
Hit and Miss Brickwork	8-9
Textured Brickwork	10-12
Projecting, Recess Brickwork	13
Brick Bonds and Pattern Brickwork	14
Glazed Brickwork	15
Special and Bespoke Brickwork	16
Brick Plinths	17
Brick Arches	18-21
Brick Bonds	22-23
References and Further Reading	24

Introduction

Perhaps the most appealing characteristic of brickwork is its attractive appearance.

The aesthetics of a project bring together all the very best elements of creativity and design.

Brick has superior properties of strength and durability and it is perfectly placed for versatile construction.

Brick aesthetics include all creative applications of brick construction and landscape features.

Brick Colour

Brickwork can be almost any colour from pale buff, through yellow, red, purple, brown, grey, blue, black and white. Some bricks are multi-coloured or glazed with reflective and translucent effect.

Brick Texture

Surface textures vary from rough, partially distorted with deep crease marks, through fine, dimpled or scratched textures to smooth and shiny surfaces.

Brick Sizes

UK Brick manufacturers make bricks to the standard size of 215mm long, 102.5mm wide and 65mm high (215 x 102.5 x 65mm) with a nominal 10mm mortar joint. This standardisation ensures that bricks conform to coordinating dimensions that allow proper bonding arrangements.

Some bricks are very regular and consistent in size and others are relatively distorted and vary within prescribed tolerances. These variations lead to characteristic appearances in the built work and require the exercise of appropriate craft skills to achieve the best results.

UK Brick manufacture is very flexible and 'non-standard' brick dimensions are fully accommodated. Bricks designed using co-ordinated dimensions will bond correctly. When laying bricks in an unconventional size or bond, consult a structural engineer for guidance.



Farn Street - Detail



Gardenmore Green - Detail



The Department Store Studios - Detail



Example of Protruding 'Diamond' Pattern - Detail

Mortar Colours

Mortar Joints

Although mortar appears on the surface of the brickwork as narrow lines, the total area of the mortar is a surprisingly large proportion of the whole wall surface.

With Stretcher bonded brickwork, in which only the long faces of the bricks are seen, the minimum number of mortar points are shown. Allowing for the conventional nominal joint thickness of 10mm the mortar joints account for over 17% of the surface area of the brickwork.

When headers are in the bond pattern, the proportion of mortar increases.

In English bond about 20% of the surface area is mortar, and in the bond consisting of headers in curved work, the proportion is nearly 25%.

Considerations of all these proportions helps to explain the often surprising effect the mortar has on brickwork appearance.

A dark tone mortar contributes to the overall darker appearance of the walling and it will tend to make the bricks themselves appear darker and richer in colour.

Conversely, a lighter mortar will make the bricks appear lighter as if the colour has been partly drawn from them.

Coloured Mortar

A wide range of light-fast colours and shades are available and these are supplied by leading manufacturers. These materials are specified in BS EN 12878 Pigments for building materials based on cement and/or lime.

Even though the pigments are chemically stable and do not significantly change their hue, all cement based materials can change their appearance over time. Coloured mortars may be more conspicuous by these changes. For example, efflorescence or lime bloom will look far more noticeable on dark mortars.

The control of variables when producing consistently coloured mortars is important. The specification of factory produced mortars ensures minimal colour variation. Mixing on site requires care in mixture proportions and consistency of the base materials, both cement and the aggregate as well as the pigment. Often pigmented mortars can appear patchy until fully dried.

Also see BDA Technical Guide: 'Mortar for Brickwork'



Typical Industry Mortar colour range



Lambeth Palace - Detail



Farn Street - Detail



Travelodge, Rochester. White Brick and Mortar - Detail

Blending Brickwork

The Issue

The nature of the brick-making process means that the final **colour and size** can fluctuate between different batches. Bricks are made from natural materials, which can have different physical qualities. Whilst manufacturing systems minimise variations as much as possible, slight variations will remain.

As variations may occur in clusters this can result in unacceptable patches, patterns or banding in completed brickwork unless good site practice is followed.

The Solution

Although some manufacturing plants can shuffle bricks as they are being packed, there is no substitute for blending on site which will disperse any irregularities and achieve an overall harmonious appearance.

All sites should agree a reference panel with the brick manufacturer prior to supply. Bricks should be selected from a minimum of three packs and it is advisable to draw from the packs in a vertical/diagonal manner, rather than horizontal layers. If a manufacturer issues specific blending instructions, these should take precedent.



Poor Practice showing bands of unblended bricks

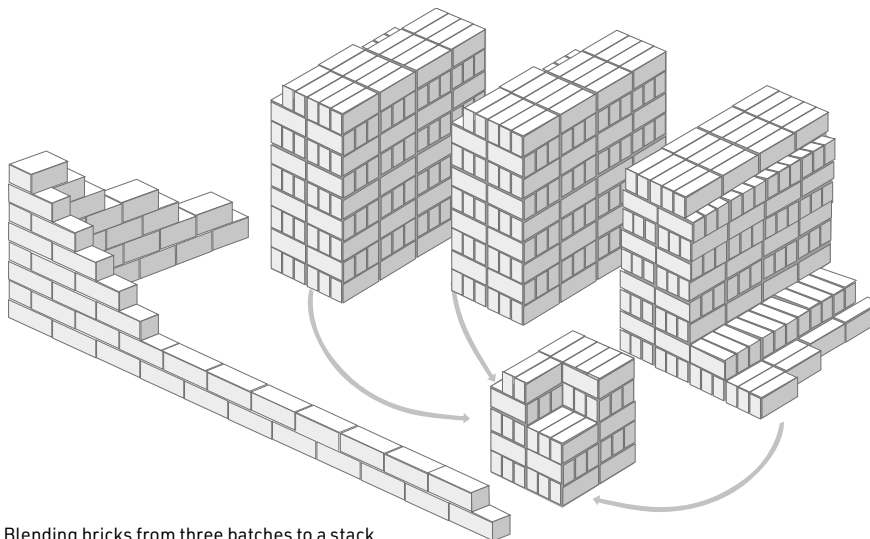

Blending bricks from three batches to a stack.

Blend brick from three Batches

For the best blending practice, remove bricks in vertical slices from at least three batches to new stack.

Further Reading More detailed information about blending and brick workmanship generally can be found in:
 BS 8000-3
 PD 6697
 NHBC standards 6.1 LABC guidance
 BDA Good site practice and workmanship

BDA Top Tips

01 Batch Deliveries
 For phased projects consider batching deliveries to plots or ask the manufacturer if they can batch supply.

02 Check Loads
 Check loads when delivered to site, and when unpacking for loading-out, so that problems can be identified before the bricks are walled.

03 Check Mortar Colour
 Blending of bricks will be to little avail if mortar colour is not consistent.

04 Blend Multi-Colours
 Blending multi-coloured bricks is just as important as blending bricks that are uniform in colour. To avoid colours being grouped together.

05 Check Preferred Face
 Although some soft mud bricks appear to have two usable faces, check with the manufacturer if there is a preferred face.

06 Loading Bays
 For upper lifts, loading bays need to accommodate at least three packs, if blending cannot take place on the ground.

Hit and Miss Brickwork

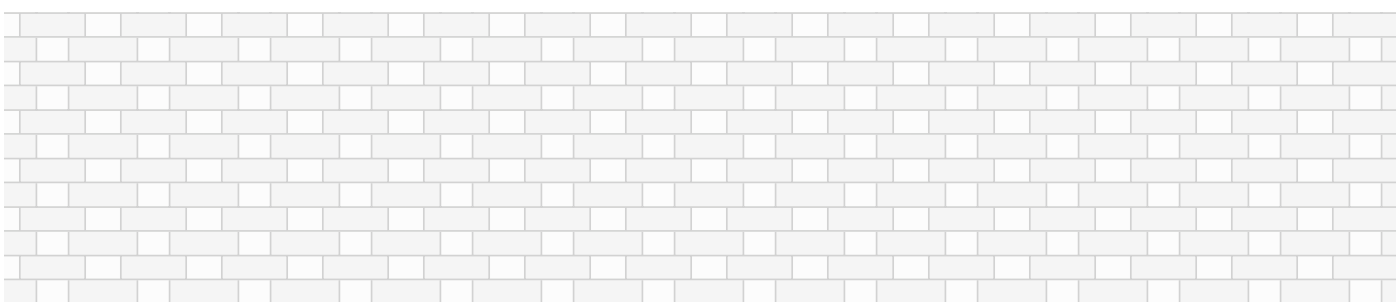
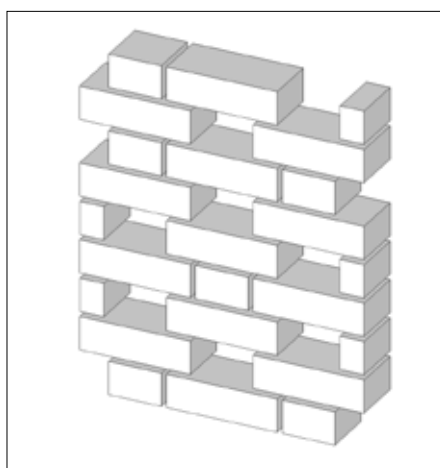
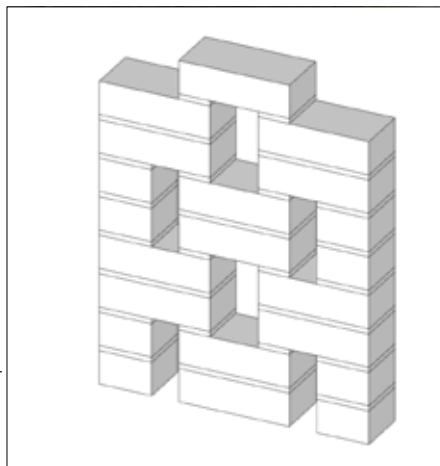
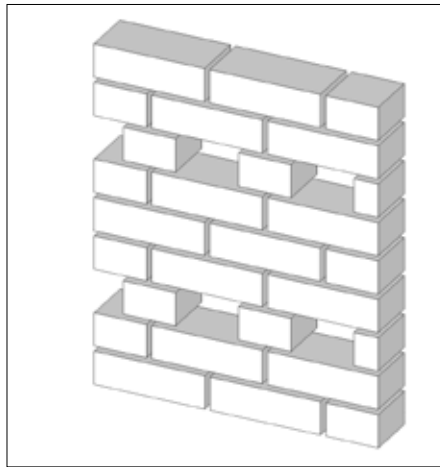
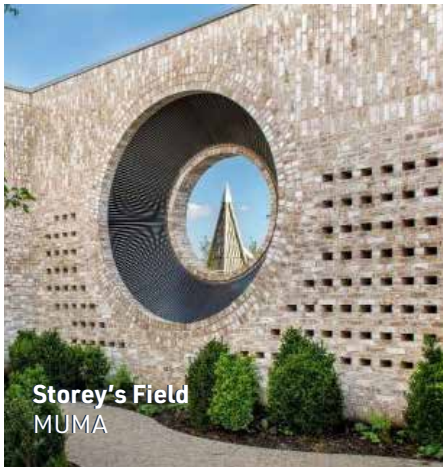

Traditional Hit and Miss Bond - Flemish bond with the header missing.

Hit and Miss Brickwork

Description

Hit and miss brickwork is generally achieved using Flemish bond with alternate header, stretcher, with the header course missing. It is one of the most flexible design aesthetics available. Traditionally used to provide a porous texture that allows light to permeate through a continuous brick facade; it adds creative potential with light and shade, ventilation and privacy in one application; without increasing cost.

A single skin brick wall is unstable and needs internal structure to tie back to. Supporting posts can be hidden between the solid element of brickwork to alleviate wind loads and improve structural integrity.

Detailing Considerations

The allowable overlap will depend on many parameters that dictate the wall's ability to provide sufficient robustness and bending resistance including:

- Wall thickness
- Unit size
- Masonry bond strength
- Spanning distances
- Bonding pattern

Changing the orientation of bricks or introducing voids in the brickwork can negatively influence the loading capacity. Consult a structural engineer for both structural and environmental issues.

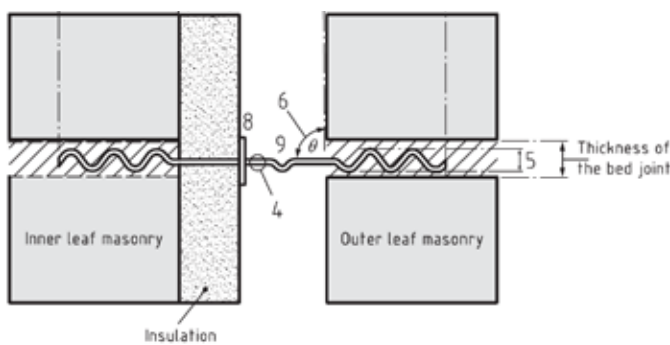

Standard cavity wall build up from PD6697. Consult a Structured Engineer for masonry support.

Design Considerations

Due to the absence of definitive testing, hit and miss panels should be supported on at least three sides; ensuring that the sections left out of a hit and miss panel are multiples of whole bricks, standard setting out dimensions can be used and cuts avoided.

When design calculations fall outside of the allowable limitations there are a number of options to achieve an acceptable result. The hit and miss panel can be split in to a number of smaller areas, with brick piers and beams used to provide additional strength.

Using a stronger mortar mix may also have a beneficial result on structural stability but care must be taken to ensure the mix is compatible with the brick specification.

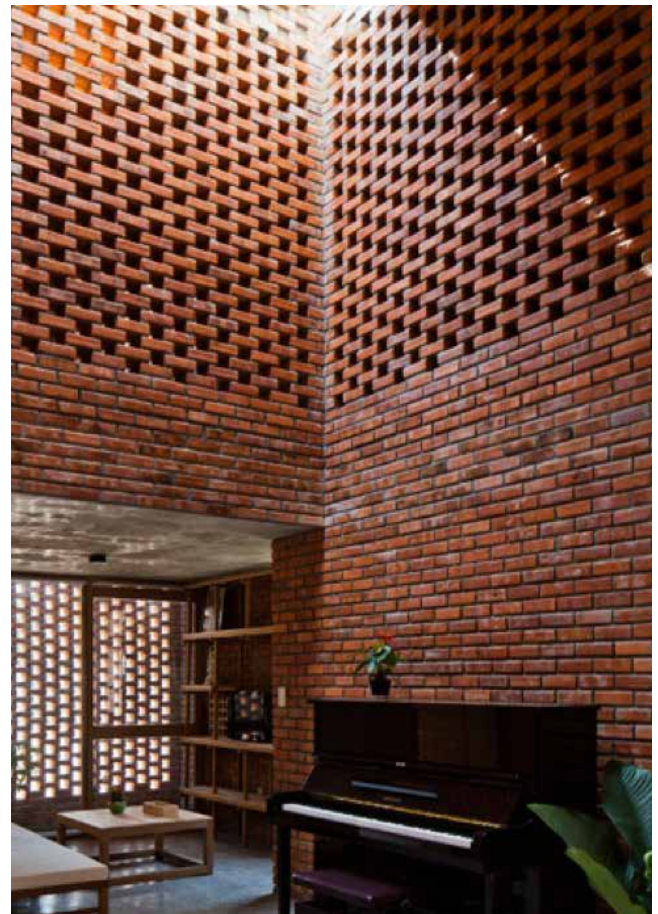

Working to whole brick dimensions will avoid cuts.

BDA Top Tips

01 Structural Engineer

Consult a structural engineer when bricks are laid in an unconventional bond.

02 Manufacturer

Consult the manufacturer to confirm that the brick specification is suitable for the intended design.

03 Brick Faces

Perforated or frogged bricks should be avoided as all faces will be visible, unless approved by the manufacturer.

04 Location

Avoid locating hit and miss panels where it may be possible for the general public to climb them.

05 Prior to Start

A site reference panel should be constructed, prior to starting, to agree product quality, design details and workmanship.

Textured Brickwork

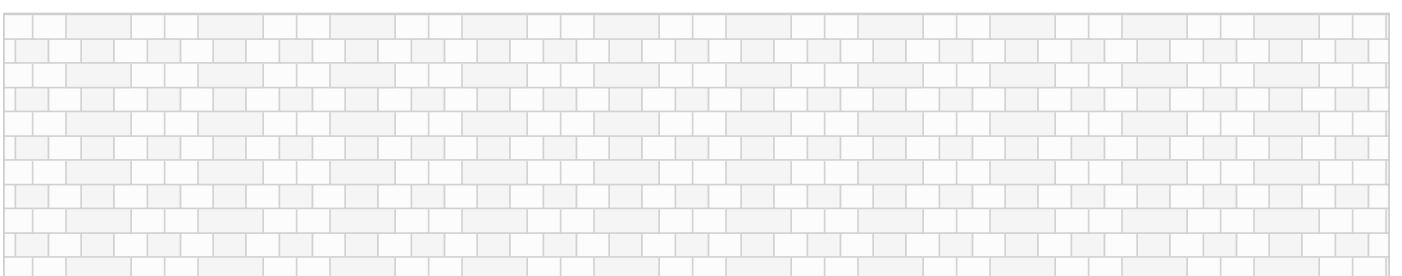
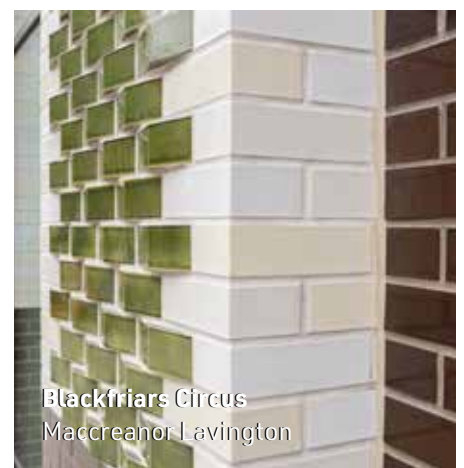
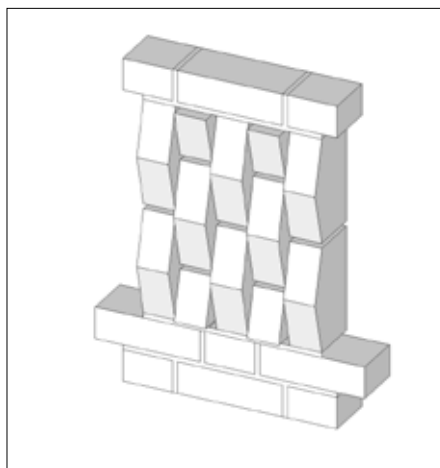
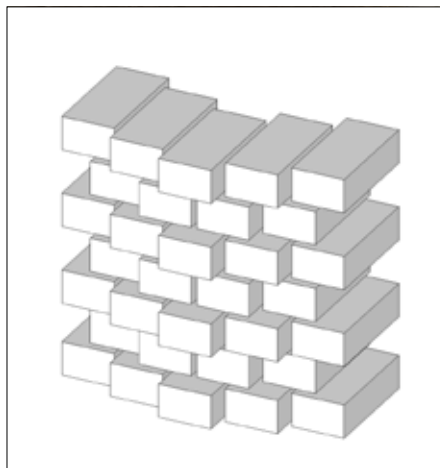
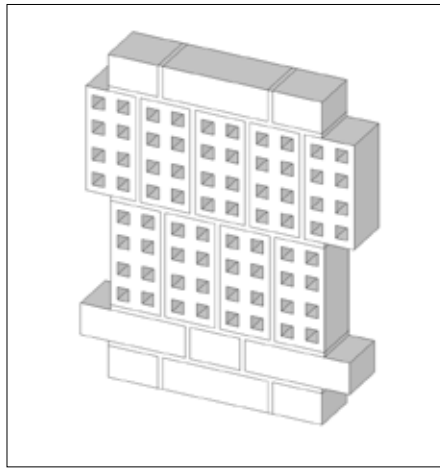
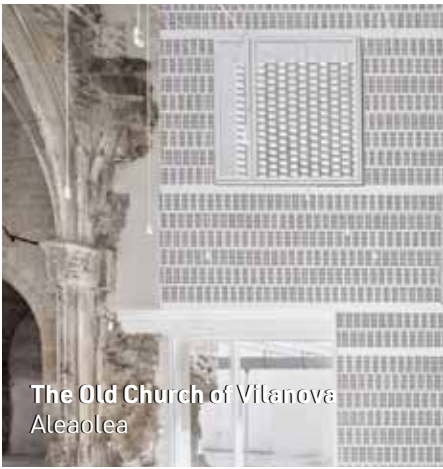

English Bond

Textured Brickwork

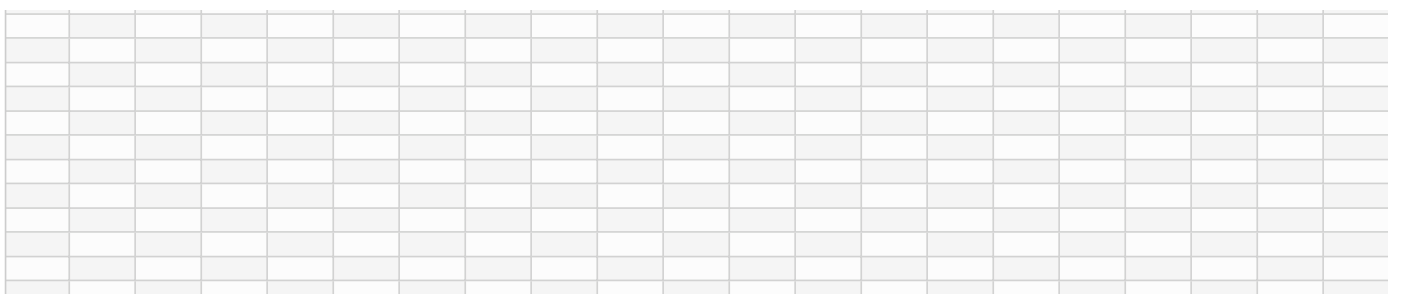
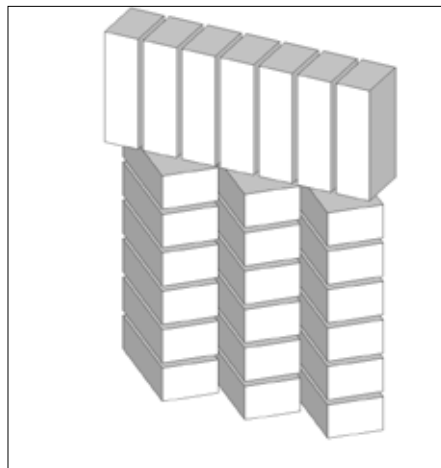
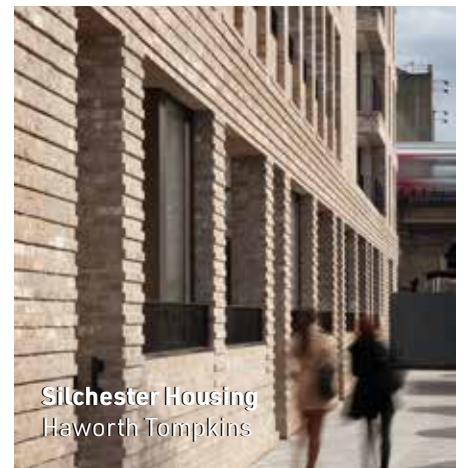
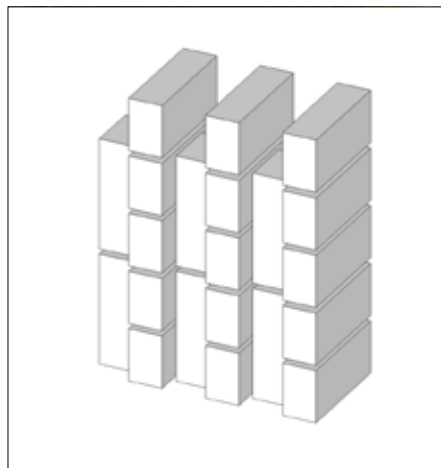
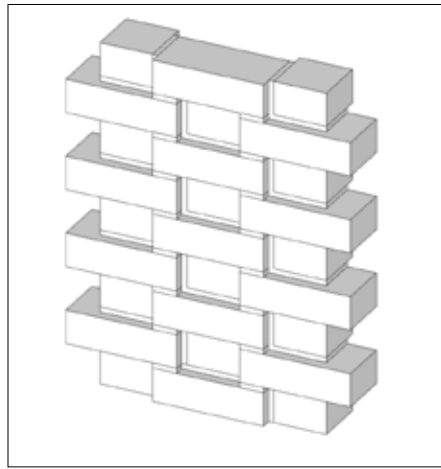

Stack Bond

Textured Brickwork

Description

Textured brickwork can be used for both non-loadbearing and loadbearing wall systems providing that they comply with the structural design requirements set out in BS 8103-2 or BS EN 1996-1-1.

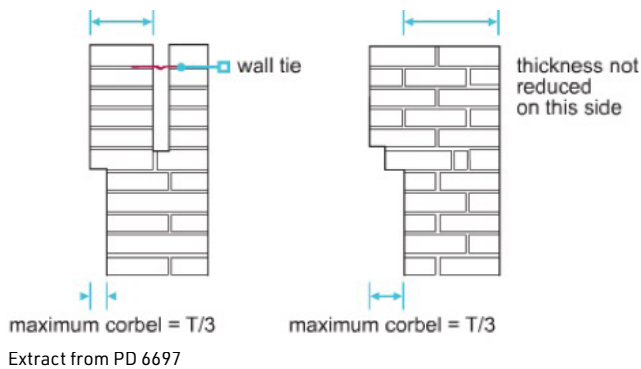

Detailing Considerations

The extent of the projection should not be more than 1/3 of the wall thickness. For cavity walls the thickness only includes the external leaf.

For common clay units of 215 x 102.5 x 65mm, laid in a flemish bond the maximum allowable projection would be 1/3 of the unit thickness (102.5mm) or 34mm. This assumes the brick is cut so that the cavity face of the external skin is flush.



Projecting headers in Flemish bond

Detailing Considerations

The design must allow for sufficient wall ties at 2.5/m² for buildings within the scope of Approved Document A, or by calculation as described by BS EN 1996-1-1

Minimum cavity widths should be maintained to ensure that the detail provides the necessary level of resistance to water penetration.



Alternate courses of stretcher bond angles at 30° from the direction of the brickwork.

Detailing Considerations

Where the textured brickwork design results in the requirement for cutting bricks, consideration should be given for any intumescent cavity fire barriers, which may need to compress against the cavity face of the external skin. Typically, these products can expand by up to 25mm, which may mean that standard flush brickwork will be required at the fire compartmentation line.

Sticking to a single brickwork bond will reduce the amount of cut bricks required and ensure that the transition from non-textured to textured areas of brickwork does not result in a continuous vertical joint. Consideration should also be given to the need to widen foundations if the extent of the corbelling results in eccentric loading for the wall design.

BDA Top Tips

01 Accuracy

Control the accuracy of brickwork by keeping neat and consistent jointing and pointing.

02 Size Tolerances

Bricks with close dimensional tolerances are advisable for most decorative brickwork. If specified ensure that only such bricks are used.

03 Brick Faces

Control accuracy of projection and overhangs and the shadows they cast. Protect the work, especially projections as the work proceeds.

04 Mortar

Control the consistency of mortar to allow rubbing down of diagonal brickwork.

05 Cut Brick

Cut dog tooth bricks accurately so as not to protrude into the cavity.

Projecting and Recessed Brickwork



Rue de Charenton Paris
Avenier Cornejo Architects



Farm Street London
Detail

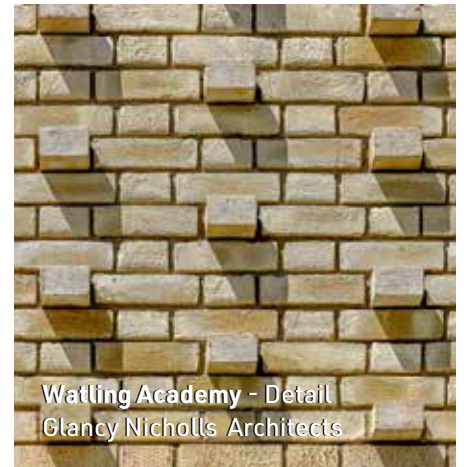

Watling Academy - Detail
Glancy Nicholls Architects

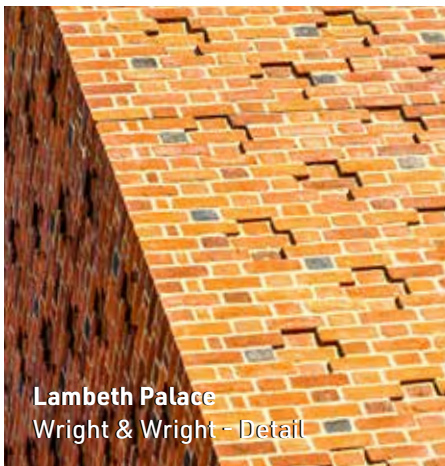

Lambeth Palace
Wright & Wright - Detail

Projecting and Recessed Bricks

Projecting and recessing brickwork can be modelled beyond the surface face of the wall.

Check with manufacturers that the surface brickwork is frost resistant and exposed brick surfaces are safe for use with rain penetration.

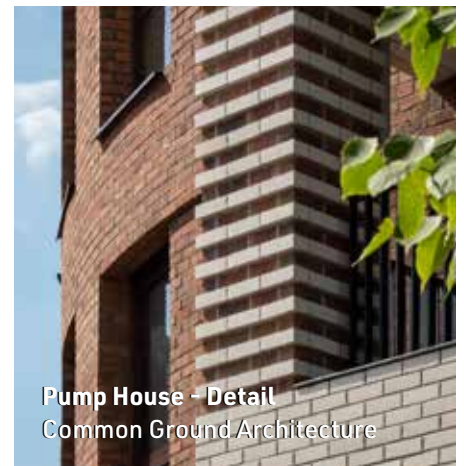

Pump House - Detail
Common Ground Architecture

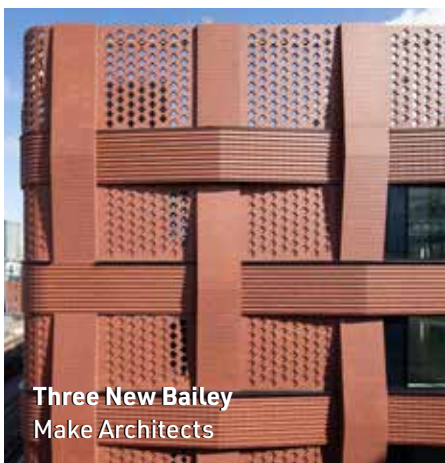

Three New Bailey
Make Architects



Odder Cemetery Chapel
Gjode & Partnere Arkitekter

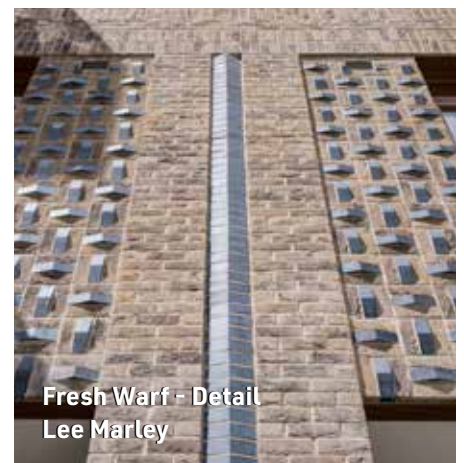

Fresh Warf - Detail
Lee Marley



Three New Bailey, Salford. Make Architects - Detail.

Brick Bonds and Pattern Brickwork

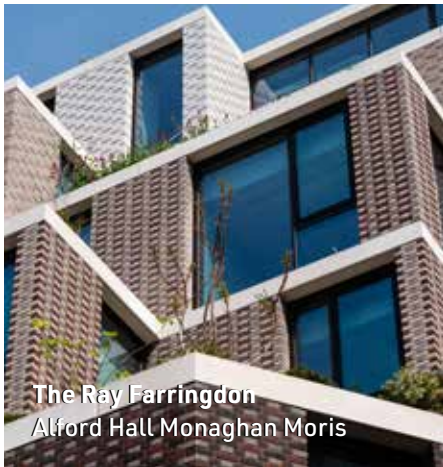

The Ray Farrington
Alford Hall Monaghan Moris

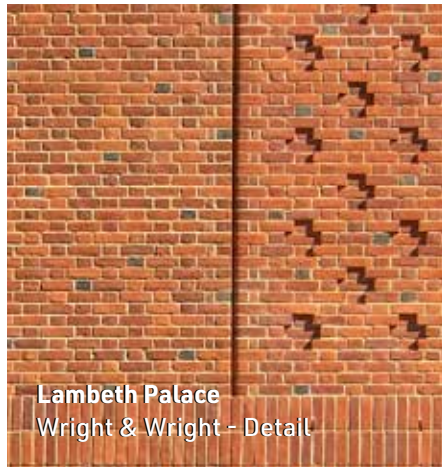

Lambeth Palace
Wright & Wright - Detail



Bethnal Green Mission Church- Detail
Gatti Routh Rhodes Architects



Fulham Palace - Detail
Purcell

Bonds

Increasingly architects are looking to use brick to create attractive bonds using brickwork in a way that is both innovative and engaging.

There are over 60 different brick bonds with a standard brick yet no two buildings are alike.

Facing brickwork laid to distinction is achieved only by careful preparation before a brick is laid and continued exercise of neat and accurate skill.



The Gilbert George Centre
Detail



APERTURE - detail
Paul Archer Design

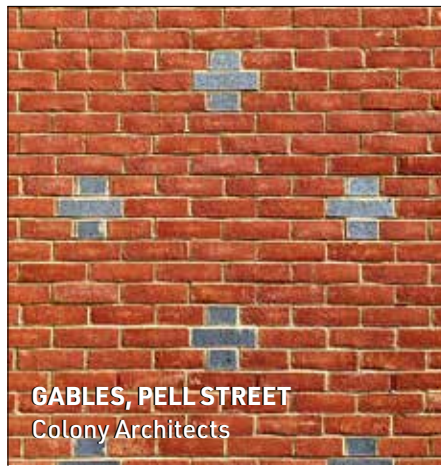

GABLES, PELL STREET
Colony Architects

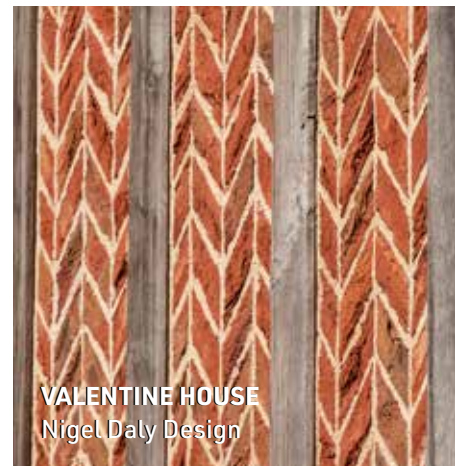

VALENTINE HOUSE
Nigel Daly Design



St Luke's Church, Blackburn - detail. Patrick Wilson Architects.

Glazed Brickwork



Coate Street
Urban Mesh

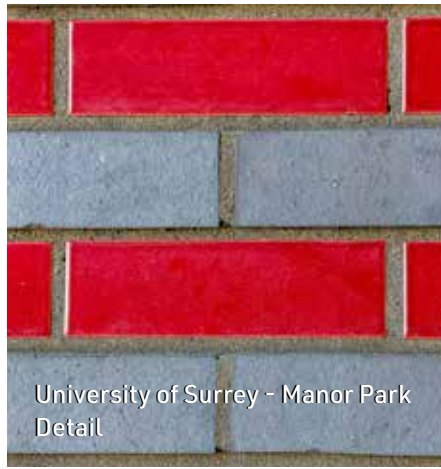

University of Surrey - Manor Park
Detail



The White House School
Burgundy glazed Brick detail

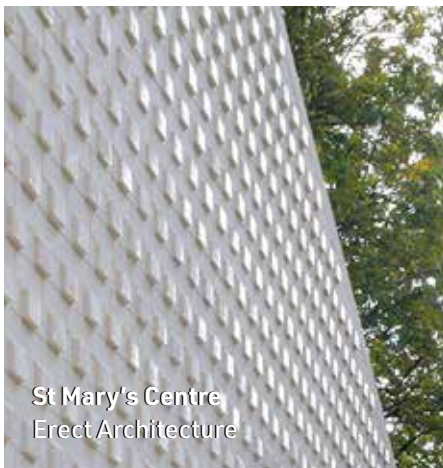

St Mary's Centre
Errect Architecture

Glazed Bricks

Glazed bricks are manufactured in almost every colour.

Light coloured bricks & glazes can help alleviate surface heat entering the building in extreme temperatures.

The light coloured masonry reflects light without causing glare; reducing the amount of heat transfer and radiation. The thermal mass of a brick absorbs the heat by day and releases it slowly overnight; smoothing the heat curve of the building.



Blackfriars Circus Detail



Beulah Studios, London



Rox Brighton
Detail

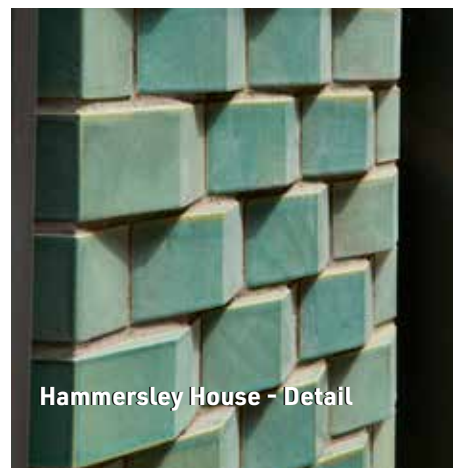

Hammersley House - Detail

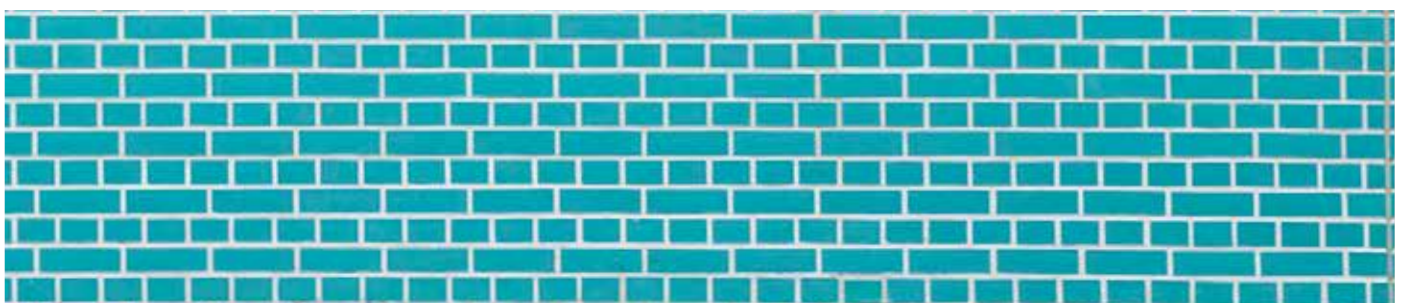

Marlborough Primary School- green glazed brick plinth - Detail

Special and Bespoke Brickwork



Little Donyland
Gruff Architects



Nursery Project
Detail



Nursery Project
Detail



Leighton House
Building Design Partnership

Special and Bespoke Brickwork
Architects and designers continue to develop new aesthetic brickwork.

Brick can be any shape or colour creating endless possibilities for circular, spiral, textures, octagonal builds and landscapes.

Internal decorative textured brickwork can also act as an aesthetic acoustic panel, absorbing unwanted ambient sound.



Mosque Leeds
Spiral brick detail

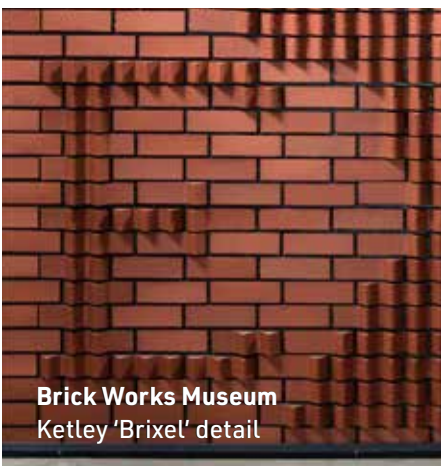

Brick Works Museum
Ketley 'Brixel' detail



The Interlock London
Bureau de change Architects

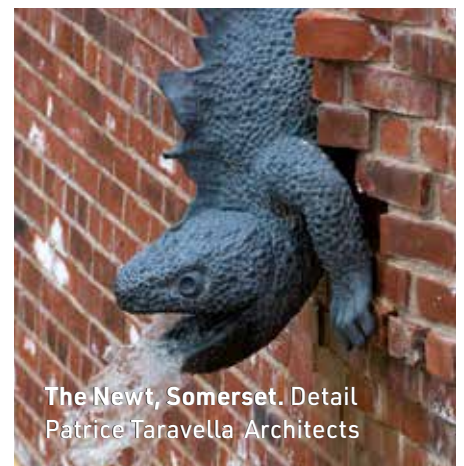

The Newt, Somerset. Detail
Patrice Taravella Architects



Peabody Burrige Gardens. Ibstock bespoke brick. Hawkins Brown Architects. - Detail of bespoke brick

Plinths

A plinth is the projected portion of a wall immediately above the ground or floor level.



Double Course Plinth

Double Course Plinth

Plinth bricks were traditionally used to reduce a wall thickness above the base, thereby forming a weathered and attractive top to a plinth.

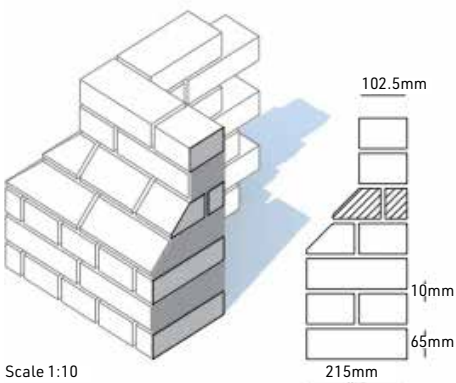

Scale 1:10

Double Course Plinth with cut facing brick behind

Care should be taken when setting-out the line and bonding of the plinth, to always bond downwards from the main face work.

It is desirable to construct a continuous width foundation to avoid the possibility of differential settlement between the plinth and the main brickwork.

The angle of the slope is dependant upon the shape of the special brick used.

Double Course Plinth with cut facing brick behind

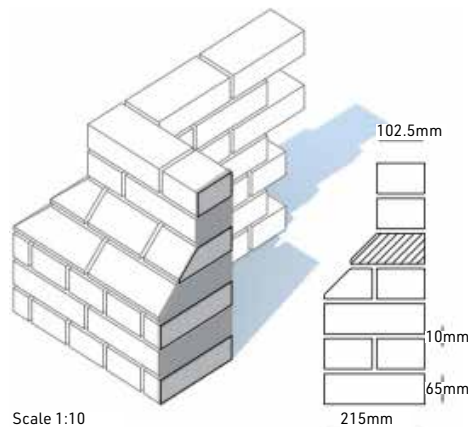

Scale 1:10

Double Course Plinth with wide bed plinth stretcher behind with standard facing brick behind



Leighton House Cafe Refurbishment
Original bricks



Leighton House Cafe Refurbishment
Building Design Partnership

Arches

Construction known as an 'arch ring', made of truncated wedge-shaped voussoirs that by mutual pressure stay in place, set out in a curved form to span an opening and carry a superimposed load.

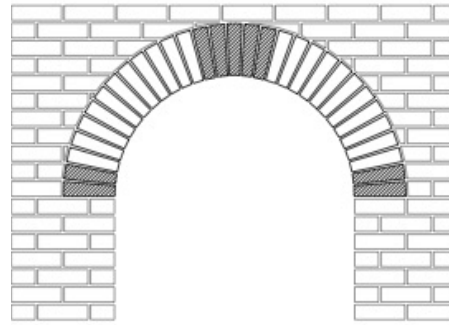

The shaded brick in the diagram highlights where the maximum strain occurs in the arch.

Semi-circular Arch

A Semi-circular Arch will always have its centre on the springing-line.

Semicircular Arch



The Arches Detail

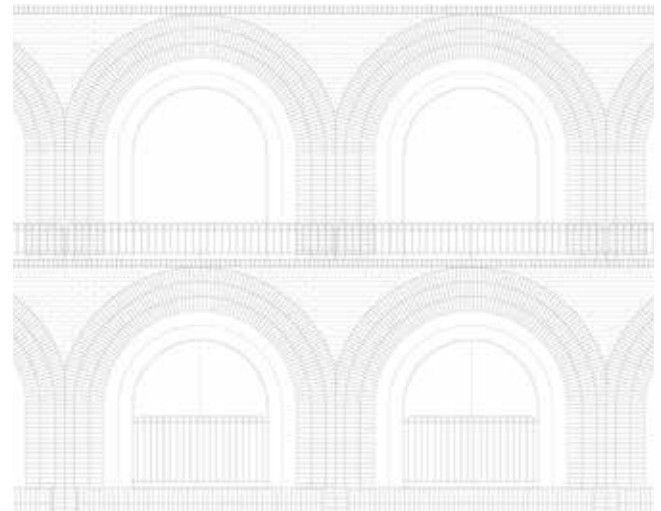

The Arches Drawing Detail



The Arches Detail
Architect Dhaus

Arches

Construction known as an 'arch ring', made of truncated wedge-shaped voussoirs that by mutual pressure stay in place, set out in a curved form to span an opening and carry a superimposed load.

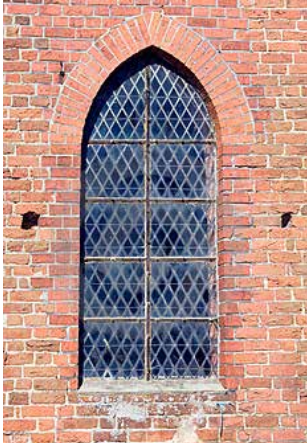

Gothic Arch

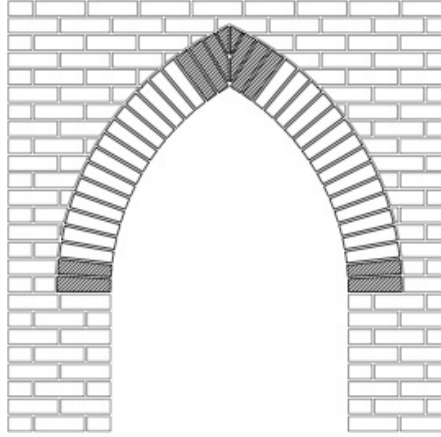

Gothic Arch

The Gothic Arch can be formed from a lancet, drop or equilateral arch. The lancet is a sharply pointed two-centred or acute type with the radii greater than the span. The drop arch is a pointed arch with its center on the springing-line and with the span longer than the radius and the equilateral is a pointed two-centred arch of two arcs, the radii of which are equal to the span.



Tudor Arch

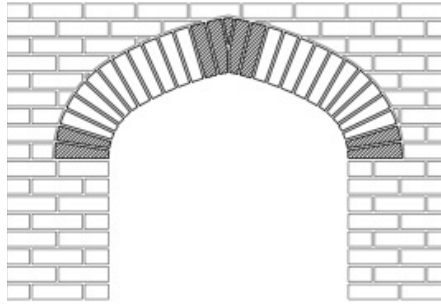

Tudor Arch

Perpendicular Arch, similar to a depressed arch, but with shanks starting at quarter circles (with centres on the springing-line) continuing as straight lines to the apex. It is very depressed, and often expressed as a single lintel.

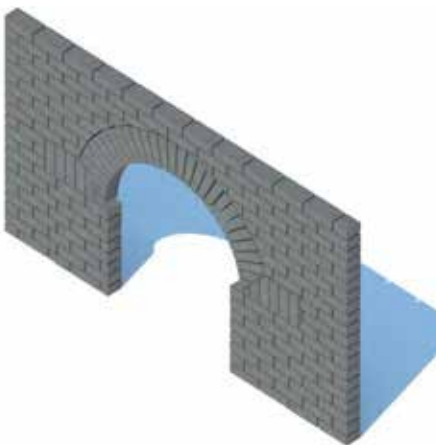

Venetian Arch

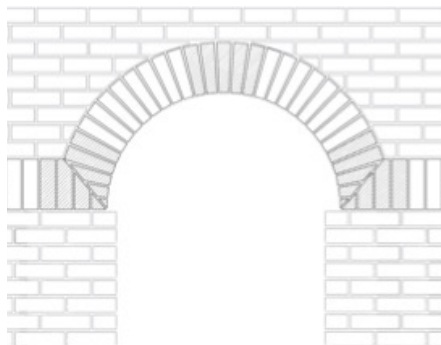

Venetian Arch

A semi-circular arch framing two semi-circular-headed lights separated by a colonnette above which is a roundel in the space between the tops of the smaller arches and the main intrados.

Arches

Construction known as an 'arch ring', made of truncated wedge-shaped voussoirs that by mutual pressure stay in place, set out in a curved form to span an opening and carry a superimposed load.



Horseshoe Arch
Storey's Field Community Centre - Detail

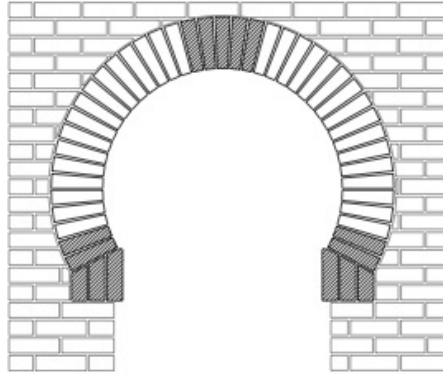

Horseshoe Arch

Usually associated with Islamic styles, formed from a semi-circular arch on straight piers narrowing towards the base below the springing-line. Other types include a pointed horseshoe arch and a round horseshoe arch.

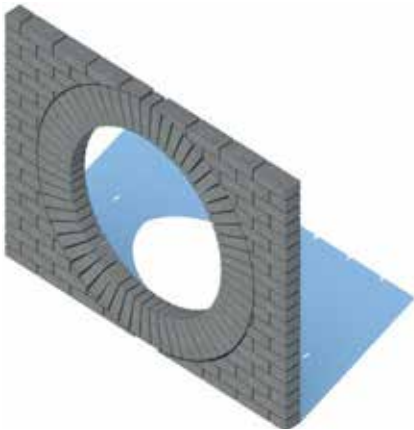

Bullseye Arch

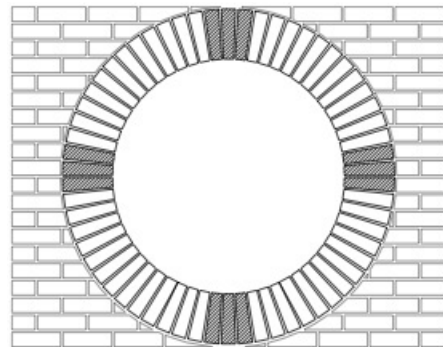

Bullseye Arch

The Bullseye Arch is commonly used for openings increasing the volume of light entering the internal space. The full circle of brick voussoirs remain in compression.

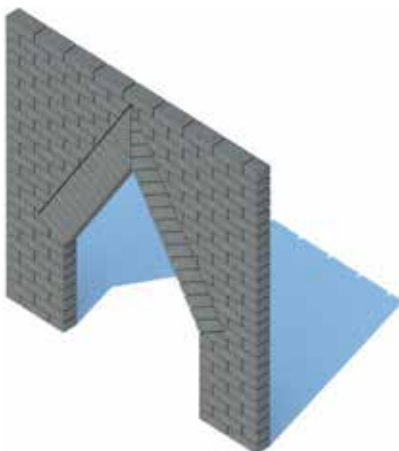

Triangular Arch

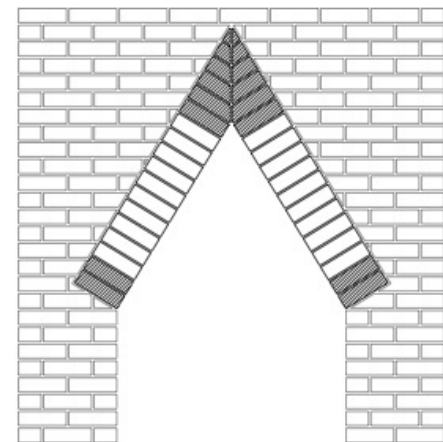

Triangular Arch

A triangular pseudo-arch of two courses of stretchers at an acute angle, lean together at a mitred apex, common in Anglo-Saxon architecture, also called pediment or mitre arch.

Arches

Construction known as an 'arch ring', made of truncated wedge-shaped voussoirs that by mutual pressure stay in place, set out in a curved form to span an opening and carry a superimposed load.



Jack Arch

The Serpentine Sackler Gallery - Detail

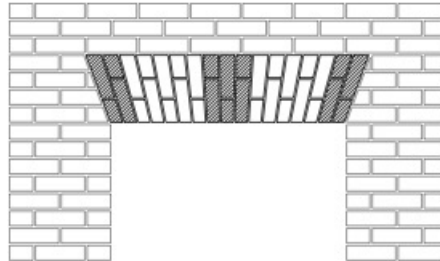

Jack Arch

The Jack Arch is a Segmental Arch spanning between iron beams, thus forming a vault.



Segmental Arch

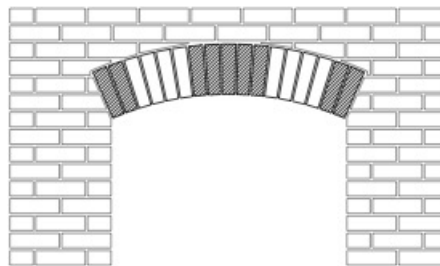

Segmental Arch

With its centre below the springing-line, a Segmental Arch can either be semi-circular or pointed which would allow for two centres below the springing-line.



Multi-Centered Arch

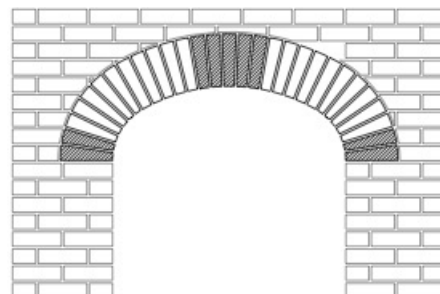

Multi-Centered Arch

Also known as a three-centred Arch with two arcs struck from the springing-line with a central arc struck from below it. A depressed three centres arch has the central arc struck from a point very much lower than the springing-line.

Brick Bonds and Pattern

A pattern in which clay bricks are laid

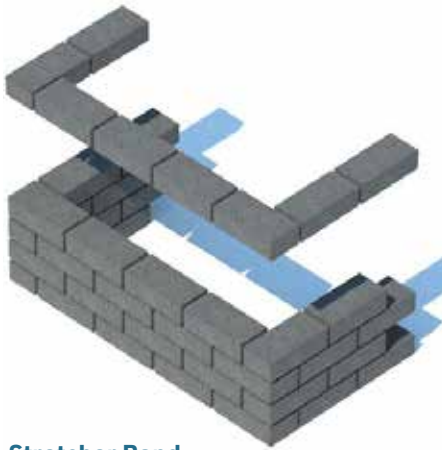

Stretcher Bond

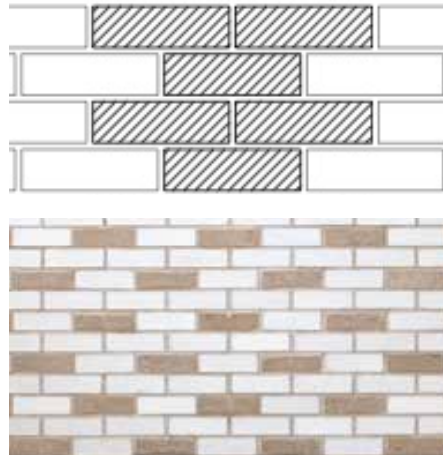

Stretcher Bond

Originally used for single brick walls, it became the obvious choice for cavity walls with the least amount of cutting required. It is therefore the most economical bond pattern and is extensively used in modern building.

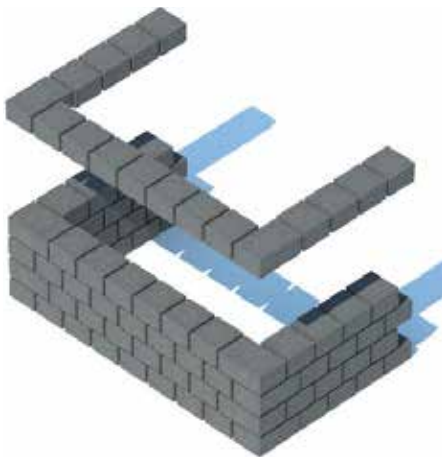

Header Bond

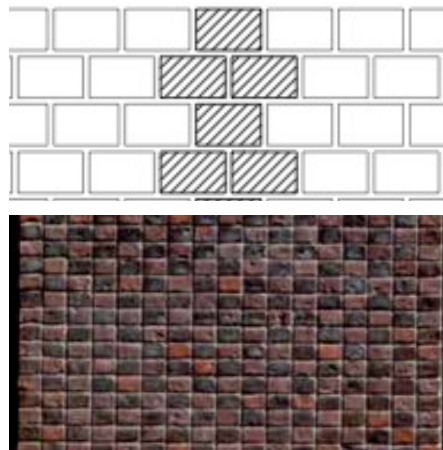

Header Bond

A brick course laid flat with the short end of the brick exposed. This method is particularly strong as the width of the wall is the whole length of a brick. Historically it was used for buildings of high quality, often used for curved brickwork.

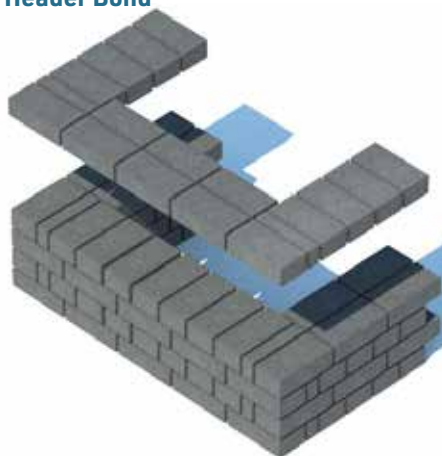

English Bond

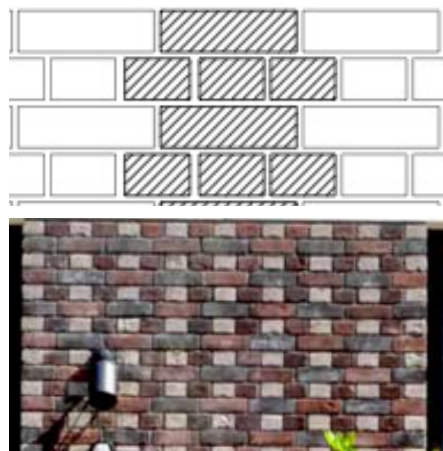

English Bond

It comprises of alternative courses of headers and stretchers. It provides a strong bond when the wall is one brick thick. It is the preferred bonding pattern for bridges, viaducts, embankment walls and other civil engineering architectures.

Brick Bonds and Pattern

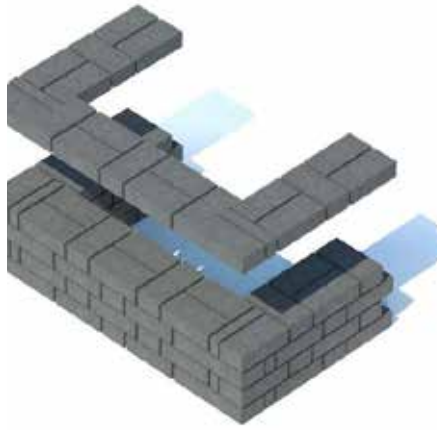

Flemish Bond

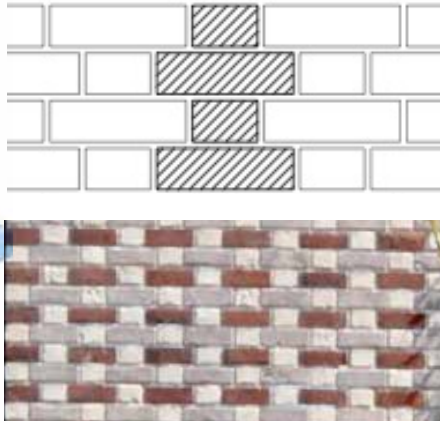

The Ray Farringdon- Detail

Flemish Bond

Flemish bonds can be replicated in the half-brick outer leaf of a cavity wall by using whole bricks as stretchers, while the headers are created by half bricks called bats or snap-headers. It is not as strong as English bond at one brick thick.

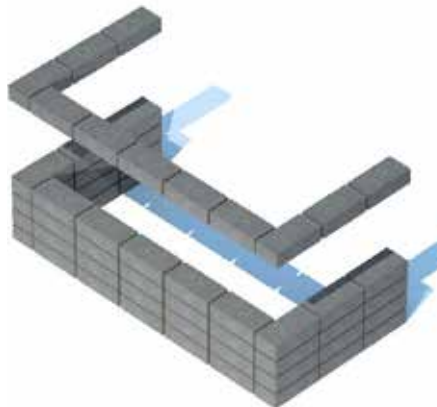

Stack Bond

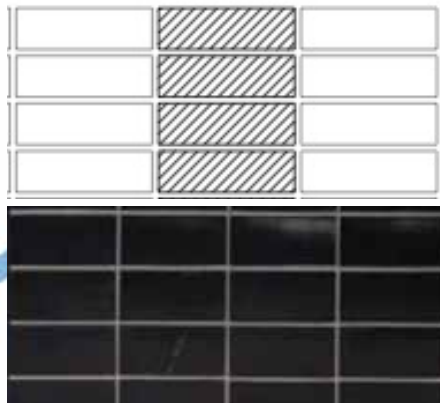

Stack Bond

In stack bond the bricks do not overlap and therefore the arrangement is inherently weak. To compensate for the lack of bonding, typically stainless steel ladder reinforcement is built into every third bed-joint.

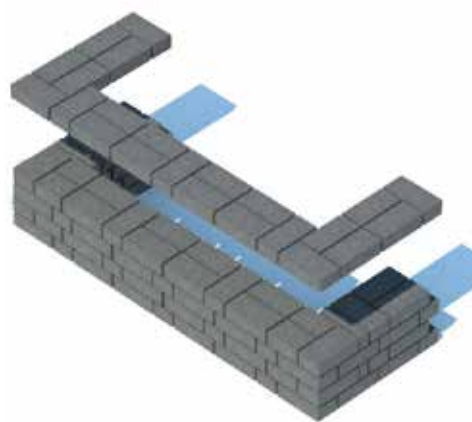

Monk Bond

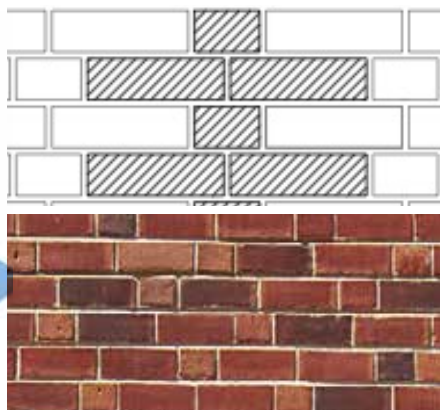

Monk Bond

With two stretchers between the headers in each row, and the headers centred over the join between the two stretchers in the row below. It was commonly used in the region around the Baltic Sea until turn of 13th and 14th centuries, then it was gradually replaced by Flemish bond.

References and Further Reading

EN 771-1, Specification for masonry units Part 1: Clay masonry units.

BS 4729, Clay and calcium silicate bricks of special shapes and sizes – Recommendations.

BS 8000-3, Workmanship on building sites – Part 3: Code of practice for masonry.

BS EN 998-2, Specification for mortar for masonry – Part 2: Masonry mortar.

BS EN 1990, Eurocode – Basis of structural design.

BS EN 1996-1-1, Eurocode 6 – Design of masonry structures – Part 1-1: General rules for reinforced and unreinforced masonry structures.

BS EN 1996-1-2, Eurocode 6 – Design of masonry structures. General rules. Structural fire design.

BS EN 1996-2, Eurocode 6 – Design of masonry structures – Part 2: Design considerations, selection of materials and execution of masonry.

BS EN 1996-3, Eurocode 6 – Design of masonry structures. Simplified calculation methods for unreinforced masonry structures.

PD 6697, Recommendations for the design of masonry structures to BS EN 1996-1-1 and BS EN 1996-2 BS 8103-2, Structural design of low-rise buildings – Part 2: Code of practice for masonry walls for housing.

Mortar

EN 771-1, Specification for masonry units Part 1: Clay masonry units.

BDA document - Good site practice and workmanship BDA document - Severely exposed brickwork.

BDA document - 'Mortar for Brickwork' - Technical Guide.

Brick Development Association

Products and Services

Brick Awards

The Brick Awards celebrate the best examples of clay brick in our built environment. Each year the awards attract over 350 entries from leading architects, housebuilders, developers and contractors; across 18 hotly contested categories. It is FREE and simple to enter on our website:
www.brick.org.uk

Brick Works Events

The BDA regularly runs courses and seminars for all those professionals involved with the design and construction of brick buildings. Please contact George Spreckley our Events & PR Manager on email: georgespreckley@brick.org.uk

The Brickmakers Quality Charter

The Brickmakers Quality Charter is a globally recognised scheme for ensuring that the bricks you procure are made by brickmakers who follow clearly identified and well established business norms in the manufacture of their clay brick & paver products.

The use of the Brickmakers Quality Charter logo on the brickmakers branding and web site, identifies, those brickmakers that meet those norms and hold correctly assessed credentials in real time. Thus we are able to assure the purchaser of the credentials expected of a responsible brickmaker meaning that the manufacture of clay bricks and pavers has reached a set of internationally recognised product, labour, quality, energy, environmental and other standards.

A full list of certified companies is available here: <https://www.brick.org.uk/bqc/bqc-approved-brickmakers>
Further details can be obtained by email at: brick@brick.org.uk



Brick Bulletin

This widely acclaimed e-magazine features the latest developments in brick design and is recognised world wide as the foremost journal of contemporary brickwork. It is available free through the 'Brick Bulletin' tab on our website: www.brick.org.uk.

Technical Publications

The BDA provides a range of technical publications and guides; which are freely available to Architects, Developers, Builders and General public on our web site: www.brick.org.uk

The Fourth Edition of 'Guide to Successful Brickwork' is available at all good book shops.

Training and Education

The BDA offers lectures and other educational services for Architects, Engineers, Developers as well as support for students and public interested in creating successful brickwork. We also provide technical input to events for practicing architects, engineers and organisations involved in continuing professional development.

Research and Testing

The BDA identifies specific areas where independent research and testing programmes are required to further the confident use of clay brick and to ensure quality.

Statistical and Marketing Information

The Brick Development Association is an independent body committed to providing authoritative information about the use of clay brick in construction.

We collate statistical information on brick production, UK deliveries, and related supply for imported products together with volume information including testing, research and development.

We provide free technical support on the use of clay brick, and encourage best practice in the use of brick in the built environment.



Published by the Brick Development Association. (BDA).

The BDA are committed to providing impartial and authoritative information. We make every effort to ensure the accuracy and quality of information and guidance when it is published. However we can take no responsibility for the subsequent use of this information, nor for any errors or omissions it may contain.

The Brick Development Association
1st Floor,
31 Worship Street,
London,
EC2A 2DY

020 7323 7034
brick@brick.org.uk
www.brick.org.uk

